

# TPBAU 400 relay - One-shot time delay

## Datasheet

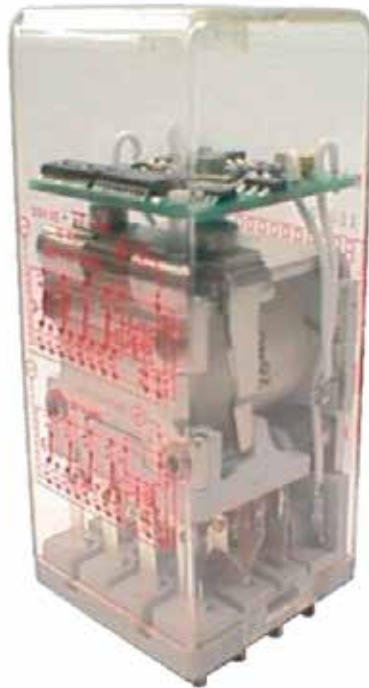

### Description

The TPBAU 400 is a one-shot on pull-in or drop-out relay with 4 double make / double break C/O contacts (form Z). The delay is triggered by the up front of the command input and is fully programmable with a dip switch from 0.25 s to 63 min. The access to dip switch is available by removing time delay cover. This feature prohibits frivolous field time delay setting.

The plug-in design offers secure locking feature for maximum ease of maintenance (no wires need to be disconnected or other hardware removed for relay inspection or replacement). The resistance to impact and vibration is conform to standards in force for Railway Transported Equipment.

Positive mechanical keying of relay to socket is built into relay and socket during manufacture and terminal identifications are clearly marked on identification plate that is permanently attached to the relay.

The TPBAU 400 relay is pluggable in the following sockets: EA 102 B, EA 102 BF, EA 103 BF, EA 104 B, EA 104 BF, EA 105 BF, EA 112 BF.

### Application

The TPBAU 400 timing relay is designed for heavy duty applications with a programmable timing function used for example in HVAC and lighting.

#### Features

- Delay on pull-in and on drop-out relay
- Delay triggered by the up front of the command input
- Delay range from 0.25 s up to 63 min
- Time delay fully programmable by dip switch
- Status LED indicator
- Plug-in design with secure locking feature for maximum ease of maintenance
- 4 double make / double break C/O contacts (form Z), 8 A
- Optional weld no transfer contacts
- Contact life (mechanical) of 100 million cycles
- -40 °C...+85 °C operating temperature

#### Benefits

- Proven reliable in heavy duty application
- Long life cycle
- Accurate timing selection finger safe
- Easy to maintain and replace
- Low life cycle cost
- No maintenance

#### Railway compliancy

- NF F 62-002 Rolling stock - Instantaneous relays contacts and sockets
- NF F 16-101/102 Fire behaviour - Railway rolling stock
- EN 50155 Railway application - Electronic equipment used on rolling stock
- IEC 61373 Railway application - shock and vibration tests



# TPBAU 400 relay

## Technical specifications



### Functional and connection diagrams

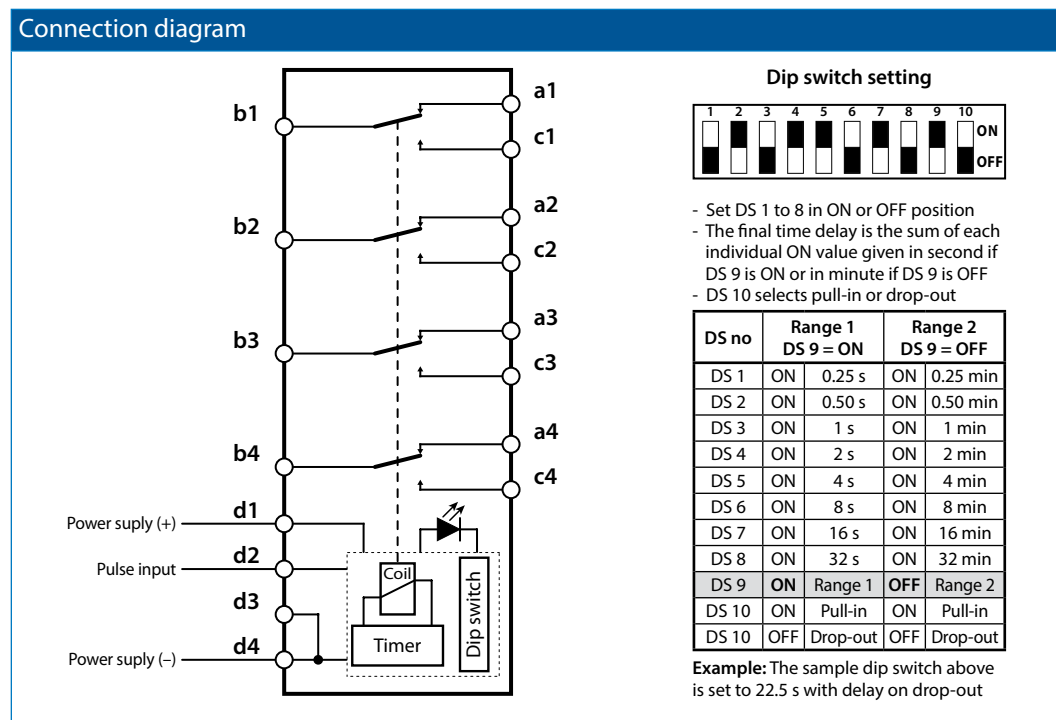
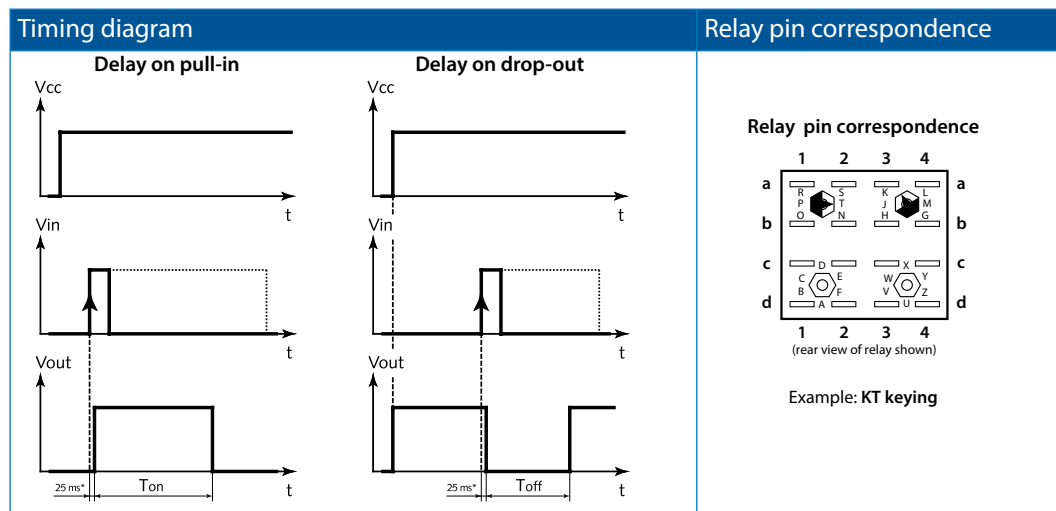

# TPBAU 400 relay

## Technical specifications

### Timing characteristics

Time function	Delay on pull-in or delay on drop-out (selection by dip switch)
Total time delay range	0.25 s...63.75 min
Time delay adjustment	Fixed after setting the dip switch (access available by removing relay cover)
Adjustment / repeatability accurat	< 2% (td > 5s), < 10% (td = 0.25 s...5s) / < 0.1% (td = time delay) (adjustment with power off)

### Coil data

Keying	U <sub>nom</sub> (VDC)	U <sub>operating</sub> (VDC)	P <sub>nom</sub> (W)	R coil (Ω) <sup>(1)</sup>	L/R (ms) <sup>(2)</sup>
GT	24	16 / 33	3	185	30
HT	36	25 / 45	3	475	30
JT	48	33 / 60	3	750	30
KT	72	48 / 90	3	1700	30
MT	96	65 / 120	3	3000	30
LT	110	75 / 138	3	4000	30

(1) Coil resistance tol.: ± 8% at 20 °C

(2) Valid for closed relay.

### Contact data

Nominal current	8 A resistive		
Nominal breaking capacity and life	1 A at 72 VDC	L/R : 0 ms	Electrical life: 5x10 <sup>6</sup> op.
	350 mA at 72 VDC	L/R: 30 ms	Electrical life: 2.5x10 <sup>6</sup> op.
	1 A at 220 VAC 50 Hz	cosØ=1	Electrical life: 2.5x10 <sup>6</sup> op.
	Lamp filament circuit: 120 W at 72 VDC		Electrical life: 5x10 <sup>5</sup> op.
Contact overload withstand	At 24 VDC: 100 A at L/R = 0 for 10 ms (10 operations at the rate of 1 operation per minute)		
Contact closure time	Pick-up time N/O < 40 ms	Drop-out* time N/C < 15 ms	
Contact opening time	Pick-up time N/C < 35 ms	Drop-out* time N/O < 6 ms	
Minimum contact continuity	20 mA at 24 VDC		
Number of contacts	4 double make / double break contacts (form Z)		
Contact material	Hard silver overlay laminated to copper		
Contact resistance	initial	10 mΩ max at 5 A	
	end of life	40 mΩ max at 5 A	



# TPBAU 400 relay

## Technical specifications

### Contact design

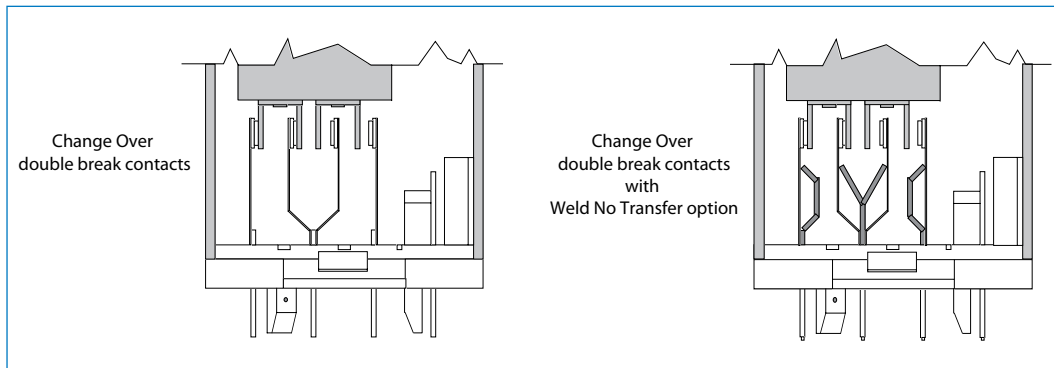

### Electrical characteristics

Dielectric strength	2000 VAC, 1 min between contacts 2600 VAC, 1 min between contacts, coil and frame
Insulation resistance	≥ 1000 MΩ at 500 VDC

### Mechanical & environmental characteristics

Vibration	NF F 62-002 The tests are conducted in the X, Y , Z planes at frequency between 10 & 150 cycles (sinusoidal) at 2 g
Shock	NF F 62-002 Tests are applied in both directions in the X, Y & Z planes. Then successive shocks are administered consisting of the positive component of sinusoidal with a value of 30 g, 11 ms Other vibration and shock tests can be performed on request
Mechanical life	> 100 x 10 <sup>6</sup> operations
Weight	300 g (10.6 ounces)
Temperature	-40 °C...+80 °C
Humidity	93% RH, 40° C for 4 days
Salt mist	5% NaCl, 35° C for 4 days
Protection	IP40 (relay on socket)
Fire & smoke	Materials: Polycarbonate (cover) / polyester melamine (base) Note: These materials have been tested for fire propagation and smoke emission according standards NF F 16-101, NF F 16-102.



# TPBAU 400 relay

## Technical specifications

### Dimensions (mm)

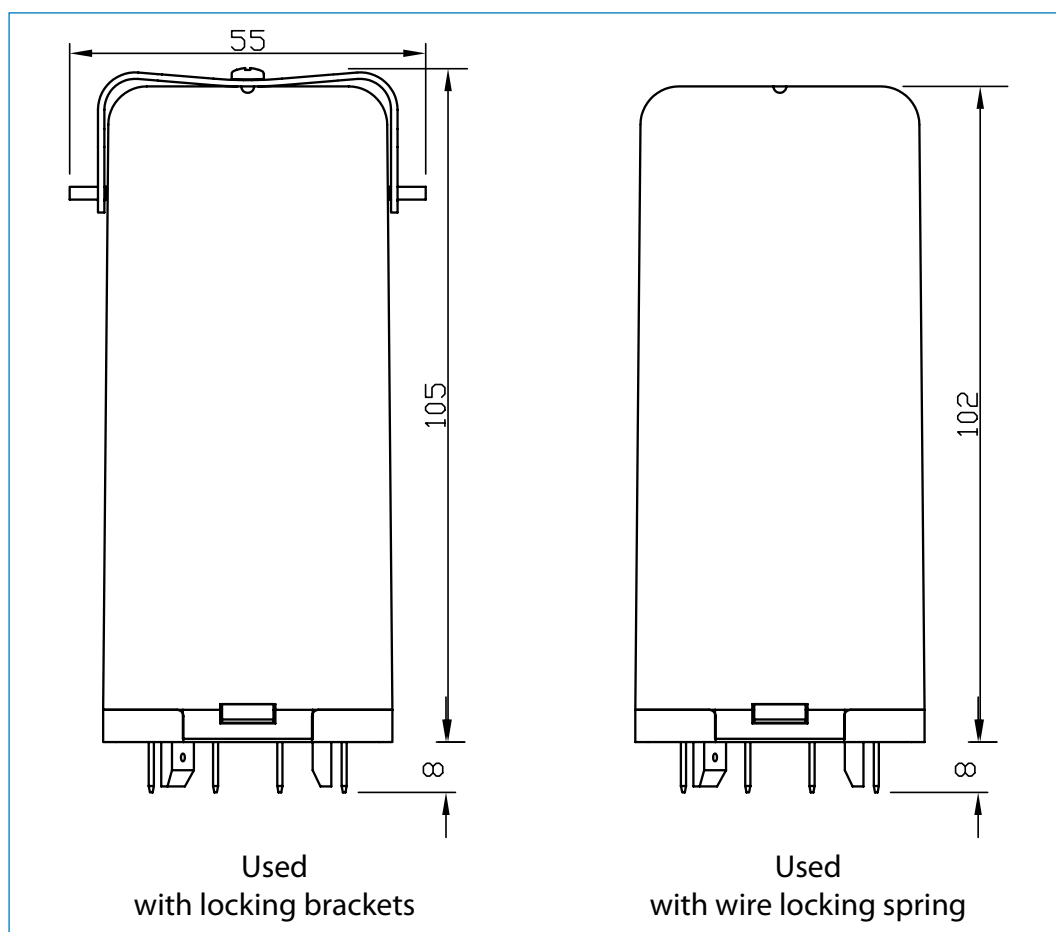

# TPBAU 400 relay

## Technical specifications

### Dynamic relay selection curve No 1

AC Current breaking capacity versus life expectancy in millions of cycles.  
Rate of contacts opening and closing = 1200 operations per hour.  
Curves shown for resistive load (Power Factor = 1).

Curve	1	2	3	4
VAC	220	125	48	24

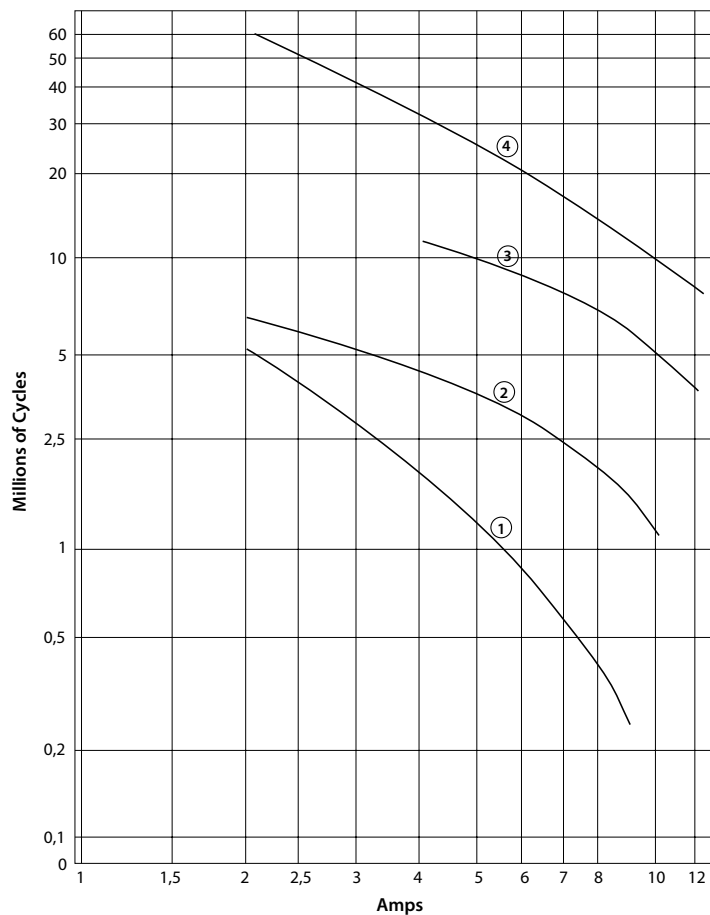

# TPBAU 400 relay

## Technical specifications

### Dynamic relay selection curve No 2

DC Current breaking capacity versus life expectancy in millions of cycles.

Rate of contacts opening and closing = 1200 operations per hour.

Curves shown for inductive load:

- L/R= 20 ms continuous current
- - - - L/R= 40 ms continuous current

\* By connecting 2 contacts in series, DC current breaking capacity increases by 50 %

Curves	1-3	2-4	5-6	7-8
VDC	220	125	48	24

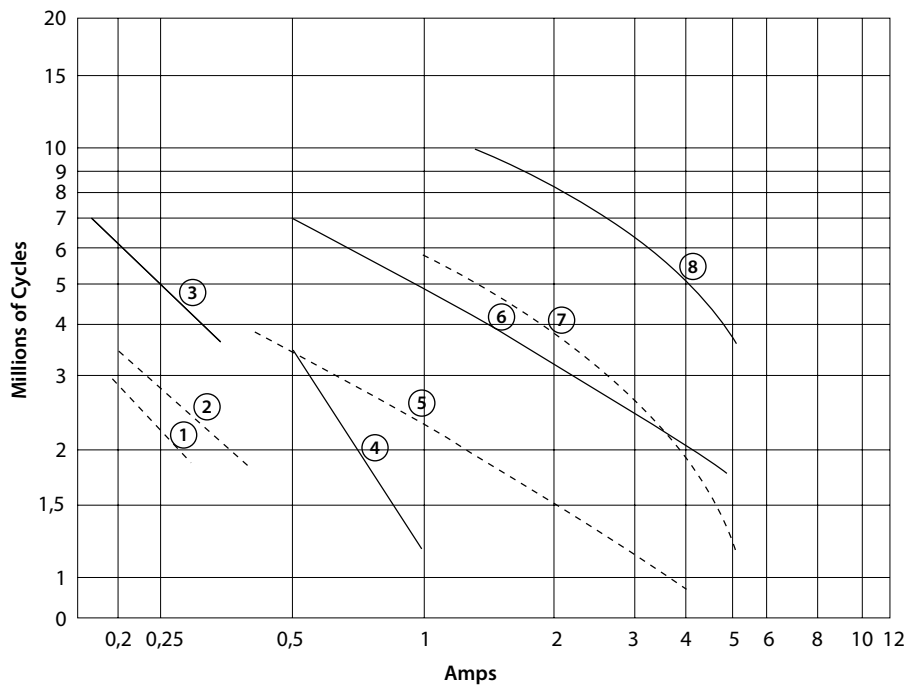

# TPBAU 400 relay

## Technical specifications

### Dynamic relay selection curve No 3

DC Current breaking capacity versus life expectancy in millions of cycles.

Rate of contacts opening and closing = 1200 operations per hour.

Curves shown for resistive load (L/R = 0). Continuous current.

\* By connecting 2 contacts in series, DC current breaking capacity increases by 50 %

Curve	1	2	3	4
VDC	220	125	48	24

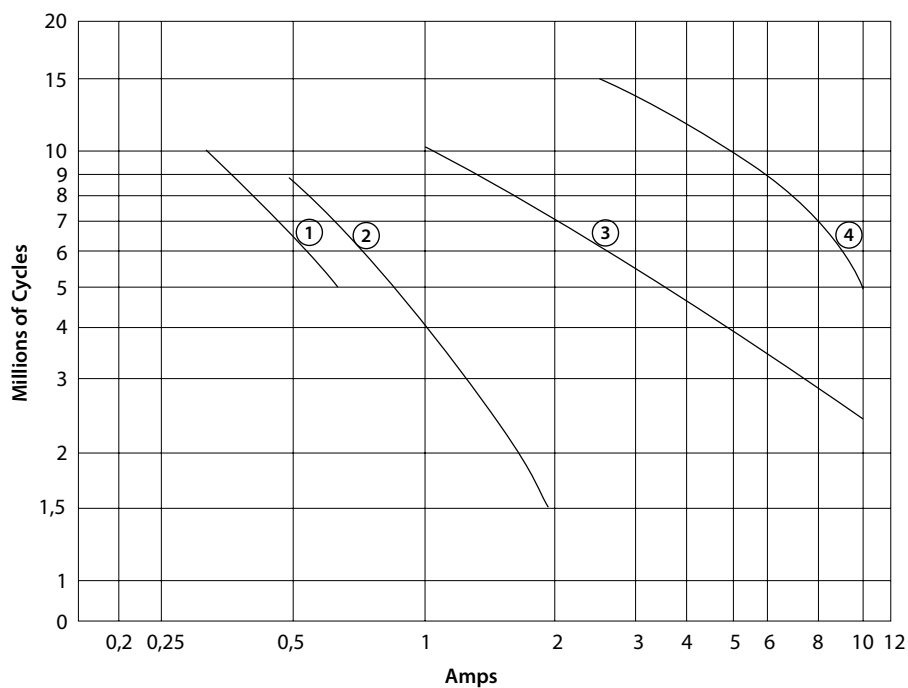



# TPBAU 400 relay

## Technical specifications

### Dynamic relay selection curve No 4

**Maximum contact breaking capacity versus voltage for a given L/R.**

Rate of contacts opening and closing = 600 operations per hour.

Curves shown for resistive load (L/R=0) and inductive loads. Continuous current.

Life expectancy: 2 Millions of Cycles

Curve	1	2	3	4	5	6
L/R=	0ms	15ms	20ms	40ms	60ms	100ms

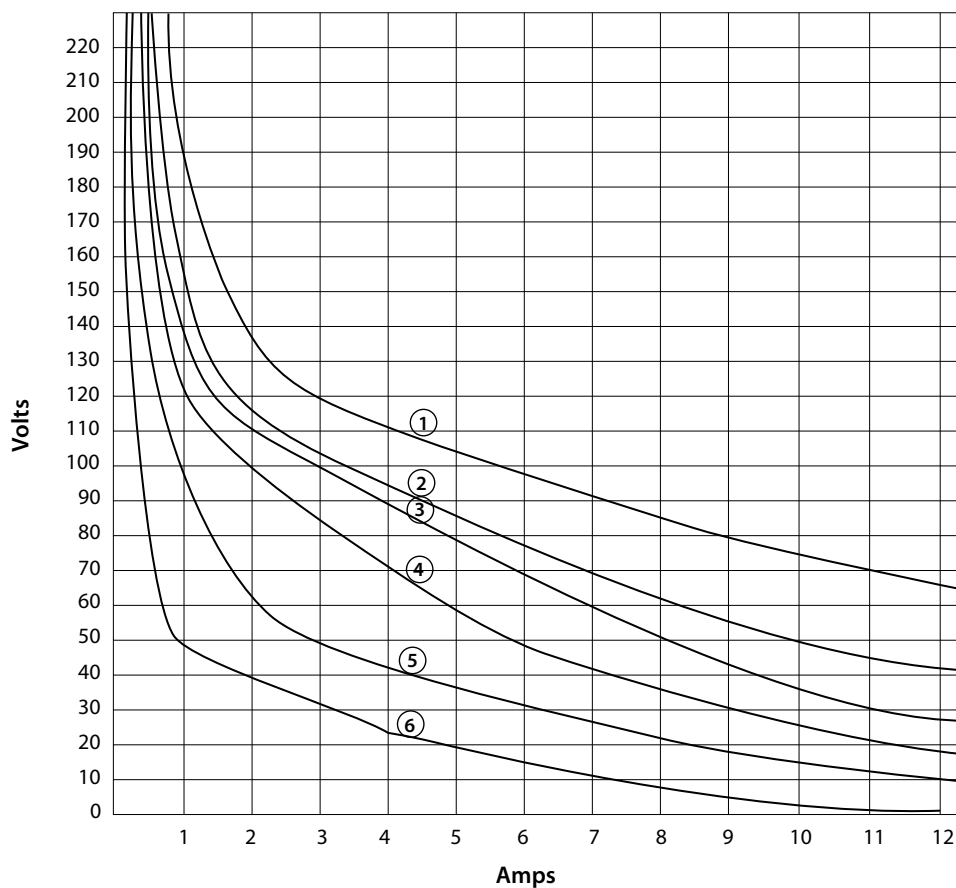

# TPBAU 400 relay

## Technical specifications

### Dynamic relay selection curve No 5

Maximum power interruption versus load time constant (L/R) for a given voltage.  
Curves shown for resistive loads.  $I = P/V$ .

Curve	1	2	3	4	5
VDC	220	125	72	48	24

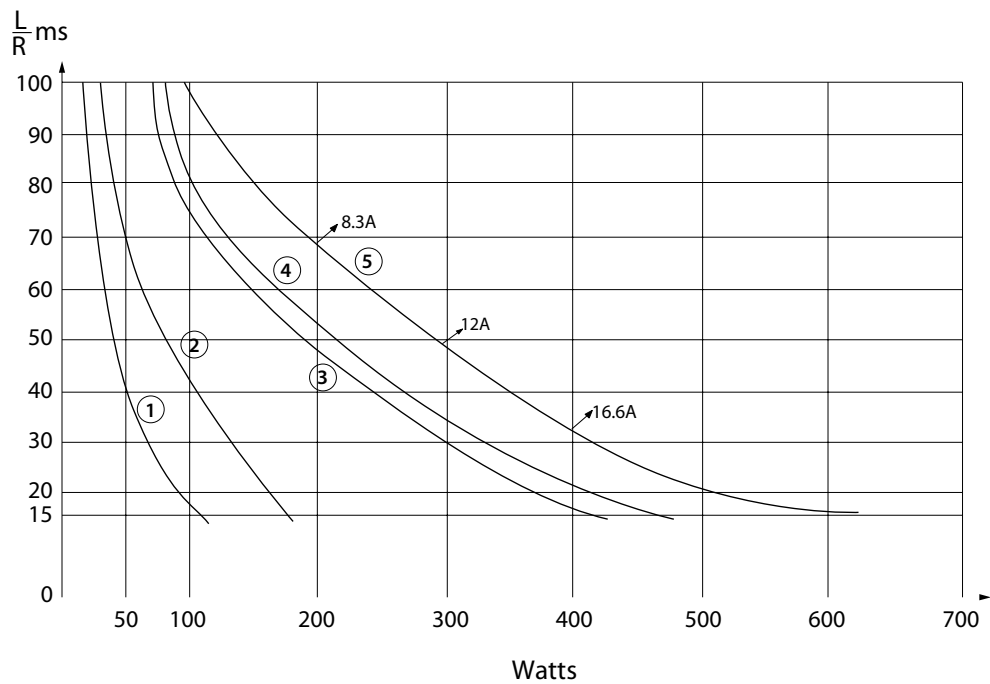

# TPBAU 400 relay

## Technical specifications

### Dynamic relay selection curve No 6

AC Current breaking capacity versus life expectancy in millions of cycles.

Rate of contacts opening and closing = 1200 operations per hour.

Values shown for inductive loads -

— Cos  $\phi$  = 0.7

- - - Cos  $\phi$  = 0.5

- · - · - Cos  $\phi$  = 0.3

Curves	1,3 &4	2,5 &7	6,9 &10	8,11 &12
VAC	220	125	48	24

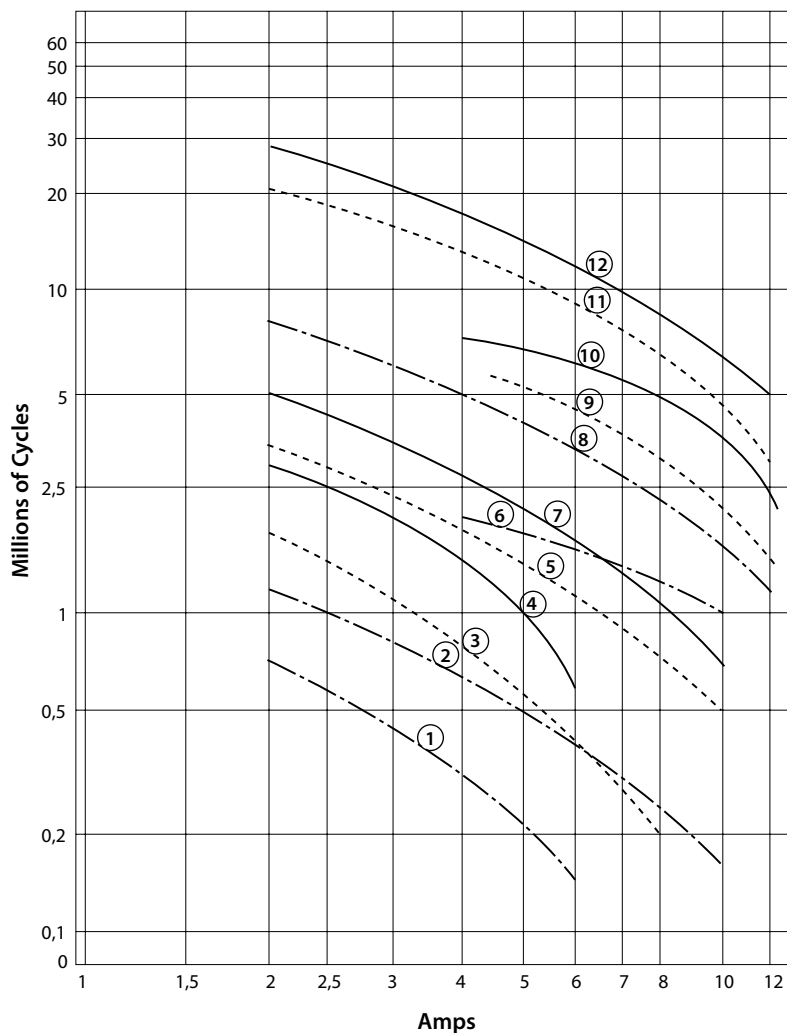

# TPBAU 400 relay

## Mounting possibilities / sockets

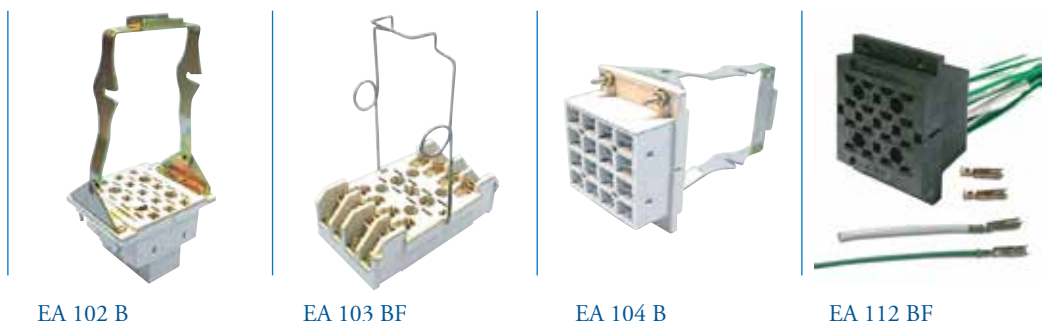

### Panel/flush mounting

EA 102 B	Locking bracket (905843), rear connection, double Faston 5 mm
EA 102 BF	Wire locking spring (926853), rear connection, single Faston 5 mm
EA 104 B	Locking bracket (905843), rear connection, single Faston 5 x 0.8 mm
EA 104 BF	Wire locking spring (926853), rear connection, single Faston 5 x 0.8 mm
EA 112 BF	Wire locking spring (926853), rear connection, crimp contact

### Surface/wall mounting

EA 103 BF*	Wire locking spring (926853), front connection, M3 screw 6.5 mm ring terminals (2,5 mm <sup>2</sup> )
EA 105 BF*	Wire locking spring (926853), front connection, single Faston 5 mm







\* Mounting possibility on 35 mm rail EN 50022 by adding suffix D to the part number (see socket datasheet)

Note: Keying of relay to socket can be specified by adding the keying letters in the part number. See all details in the related socket datasheet.

# TPBAU 400 relay

## Spare parts

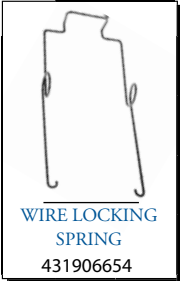
### Spare parts - order part numbers

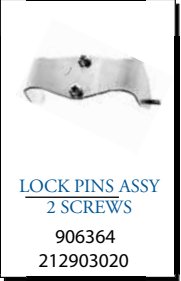
(1)  LOCKING BRACKET 905846	(1)  SCREW FOR BRACKET C927210	(1)  METAL STRAP (2) P928060	(1)  METAL STRAP (4) P928061
(1)  WIRE LOCKING SPRING 431906654	(1)  ROUND PLASTIC PLUGS 414928005	(2)  HEX. PLASTIC KEYS 414905678	(3)  LOCK PINS ASSY 2 SCREWS 906364 212903020

(1) Parts only for socket  
 (2) Parts for relay and socket  
 (3) Parts only for relay



# TPBAU 400 relay

## Instructions

### Installation

Install socket and connect wiring correctly according identification to terminals. Plug relay into socket. Reverse installation into socket not possible due to mechanical blocking by snap-lock.

Don't reverse polarity of coil connection. Relays can be mounted (tightly) next to each other and in any attitude.

**Warning!** Never use silicon near by relays

### Operation

Before operating always apply voltage to coil to check correct operation.

Long term storage may corrode the silver on the relay pins. Just by plugging the relay into the socket, the female bifurcated receivers will automatically clean the corrosion on the pins and guarantee a good connection.

Do not use the relay in places with flammable gas as the arc generated from switching could ignite gasses.

### Maintenance

Correct operation of relay can easily be checked as transparent cover gives good visibility on the moving contacts. When the relay doesn't seem to operate correct, please check presence of coil voltage. Use a multimeter. If LED is used, coil presence should be indicated. If coil voltage is present, but the relay doesn't work, a short circuit of suppression diode is possible (The coil connection was reversed). If relay doesn't work after inspection, please replace relay unit by a similar model. Send defective relay back to manufacturer. Normal wear and tear excluded.



# TPBAU 400 relay

## Ordering scheme

Configuration:



This example represents a **TPBAU 400 72 KT C F 1**.

**Description:** TPBAU relay,  $U_{nom}$ : 72 VDC, keying KT, weld no transfer, relay cover for wire locking spring, test report in English

### 1. Relay model

**TPBAU 400**

### 2 & 3. Nominal voltage and keying

<b>24 GT</b>	24 VDC
<b>36 HT</b>	36 VDC
<b>48 JT</b>	48 VDC
<b>72 KT</b>	72 VDC
<b>96 MT</b>	96 VDC
<b>110 LT</b>	110 VDC

### 4. Weld no transfer option

–	Regular double break contacts
<b>C</b>	Weld no transfer

### 5. Relay cover type

–	Relay cover with lock pins
<b>F</b>	Relay cover for wire locking spring

### 6. Language on test report

–	French
<b>1</b>	English
<b>2</b>	Spanish



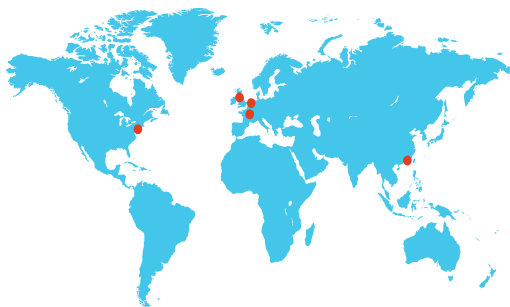

Mors Smitt France SAS

Tour Rosny 2, Avenue du Général de Gaulle,  
F - 93118 Rosny-sous-Bois Cedex, FRANCE  
T +33 (0)1 4812 1440, F +33 (0)1 4855 9001  
E [sales@msrelais.com](mailto:sales@msrelais.com)

Mors Smitt Asia Ltd.

# 807, Billion Trade Centre, 31 Hung To Road  
Kwun Tong, Kowloon, HONG KONG SAR  
T +852 2343 5555, F +852 2343 6555  
E [info@morssmitt.hk](mailto:info@morssmitt.hk)

Mors Smitt B.V.

Vrieslantlaan 6, 3526 AA Utrecht,  
NETHERLANDS  
T +31 (0)30 288 1311, F +31 (0)30 289 8816  
E [sales@nieaf-smitt.nl](mailto:sales@nieaf-smitt.nl)

Mors Smitt Technologies Inc.

420 Sackett Point Road  
North Haven, CT 06473, USA  
T +1 (203) 287 8858, F +1 (888) 287 8852  
E [mstechnologies@msrelais.com](mailto:mstechnologies@msrelais.com)

Mors Smitt UK Ltd.

Doulton Road, Cradley Heath  
West Midlands, B64 5QB, UK  
T +44 (0)1384 567 755, F +44 (0)1384 567 710  
E [info@morssmitt.co.uk](mailto:info@morssmitt.co.uk)